

Operation and Installation Manual

Without WI-FI Type



Contents

1. Introduction.....	3
1.1. Introduction of products	3
1.2. Standard configuration.....	3
1.3. Optional configuration.....	4
1.4. Characteristic.....	4
2. Function.....	4
2.1 LCD monitor.....	4
2.2 Teeth bleaching.....	5
2.3 intra oral camera	5
3. Operation.....	6
3.1 Teeth bleaching.....	6
3.2 intra oral camera.....	8
3.3 Assembling instruction illustration.....	12
4. How to resolve troubles.....	14
5 Notice.....	15

1. Introduction

1.1. Introduction of products

Dear customers,

Thanks for buying our company's products, this product is a multifunctional teeth bleaching machine, it contains teeth bleaching, intra oral camera and 8inch monitor. It makes the machine more useful and convenient.

1.2. Standard configuration

1.M-86 Teeth Whitening Accelerator	1 piece
2. M-868A (Special for M-86) LCD	1 piece
3 CF-986 intra oral camera	1 piece
4. Teeth Whitening Accelerator's foot stand	1 piece
5. Teeth Whitening Accelerator's remote control	1 piece
6. camera 5pin cable(1.5M)	1 piece
7. TF card+card converter+small white box+USB card reader	1 set
8. 12V adaptor(white colour)	1 piece
9.Goggles	2 piece
10.Camera sleeves	50 piece
11. Power supply	1 piece
12.Mouth retractor	1 piece
13. lampshade	20 piece
14. Assembly Tool	1 piece
15.Camera holder	1 piece
16.AV cable	1 piece
17.Disk(Manual inside)	1 piece

1.3. Optional configuration

- 1, Wireless transmitter M-91B
- 2, Wireless receiver M-97B
- 3, Small screen M-99

1.4. Characteristic

1. Combines 8inch LCD monitor, teeth whitening machine and an intra oral camera. It's a multi-functional all-in-one teeth whitening machine. .
2. High efficiency goose pipe design, adjust angle at random, convenient for use.
3. Combination of 4 pieces High power LED.
4. Tunable bleaching time with microprocessor-controlled timer presets.
5. High pixels for dental camera with built-in SD card, it can save the pictures permanently.
6. Convenient for dentist to make a contrast before and after treatment from the screen.
7. High sensitive infrared remote control function.
8. Small base size design, suitable use in dental clinic
9. Can upgrade to wireless and wired system

2. Function

2.1 8 inch LCD monitor Specification:

1. LCD size: 8 inch (Diagonal)
2. Driver element: a-Si TFT active matrix
3. Resolution: 640* 3(RGB) *480
4. Display mode: Normally white. Transmissive
5. Dot pitch: 0.0529(W)*0.1587(H)mm
6. Active area: 101.568(W)* 76.176(H) mm
7. Module size: 117.56(W) * 88.43(H) *5.7(D) mm
8. Surface treatment: Anti-Glare
9. Color arrangement: RGB-stripe
10. Interface: Digital
11. Backlight Power consumption: 1. 2000W (Typ.)
12. Panel Power consumption: 0.193(Typ.)
13. Weight: 175g

2.2 Teeth bleaching Specification:

Broad Spectrum: 420nm~472.5nm (Host lamps)

Light Output power: up to 2000Mw/CM²

100-240V, 50/60Hz, 1.2 A for global use

Weight: 8 Kg

Max. Working Radius: 50cm

High Uniformity of light output

Distance between teeth and Illuminator(mm)	Uniformity
1mm	Above80%
3mm	Above80%
5mm	Above80%
10mm	Above80%

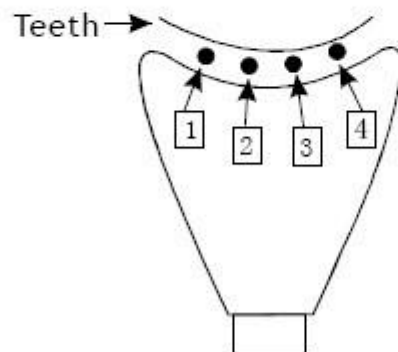

2.3 Intra oral camera Specification:

1. 1/4 CMOS 1.3 MP
2. Video or USB output
3. High resolution, High sensitivity, High performance
4. Reliable light source with 6 pieces of white light LED
5. Compact Size, Easy to use and focus

- 6. 2 or 3 buttons control, can control previous picture, next picture, and delete picture from the cameras directly
- 7. 2 capture angles, display the clear images
- 8. Built in protection voltage
- 9. Camera with 512mb Micro TF card inside it, it can save more than 500 pictures.

3. Teeth bleaching operation

Front

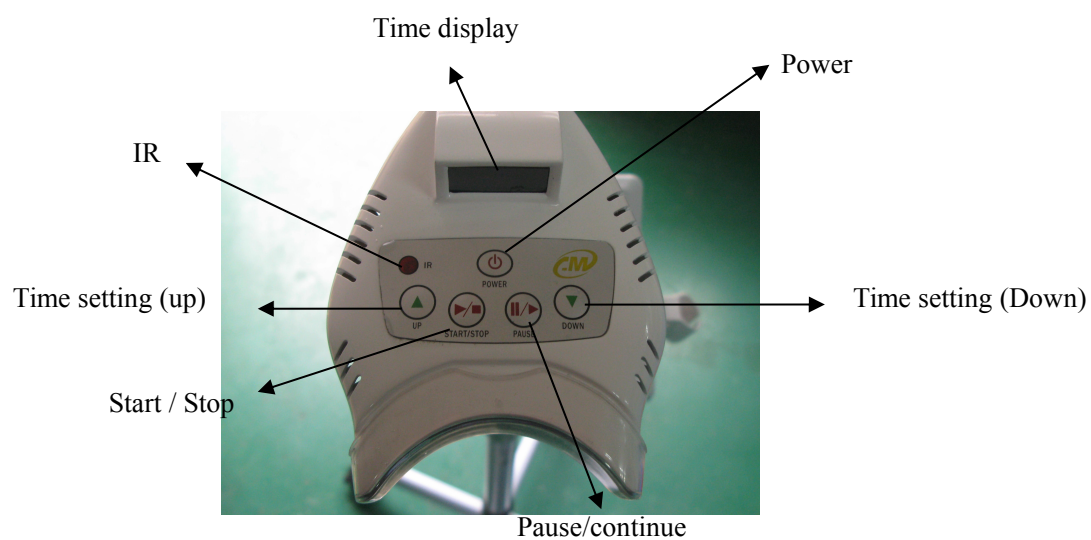

Remote control

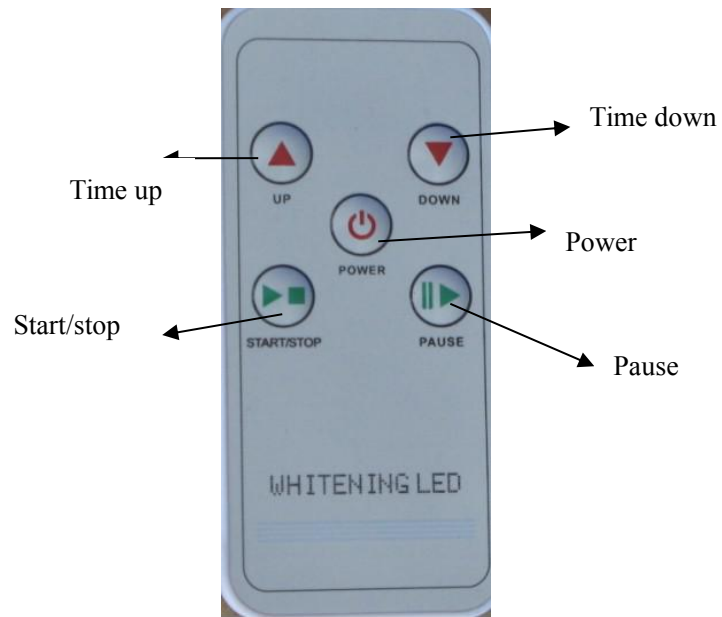

Reverse:



Power on/off

- Turn on the teeth Whitening Accelerator:
- A) plug in the teeth whitening Accelerator
 - B) Turn on the power switch.

Warning: When overload, built-in fuse blows, teeth whitening accelerator will power off, after change the fuse, the teeth whitening accelerator will be in normal operating condition.

Operating the Teeth whitening Accelerator:

- A) Start/ Stop Button: Turn on /off the light by pressing the “STOP/START “button.
- B) Pause button: Stop the time counting and emitting light by pressing the “Pause” button, the remaining whitening time will sparkle on the digital indicator. Press the “Pause” button again, light will emit and time will count continually.
- C) UP/Down Button: Use “UP” or “Down” button to set whitening time. 5 minute counting with memory , the longest whitening time is 30 minutes each cycle

3.2 Intra oral camera’s operation

A. The right side



- 1. Press option 1, Power on the camera; press option 2 for a longer time, power off the camera
- 2. Press option 1, freeze the image; press option 2, save image into SD card.
- 3. Press option 3, check the previous image
- 4. Press option 4, check the next image
- 5. Delete the image
- 6. M-99 small screen is an optional part

B. The back side

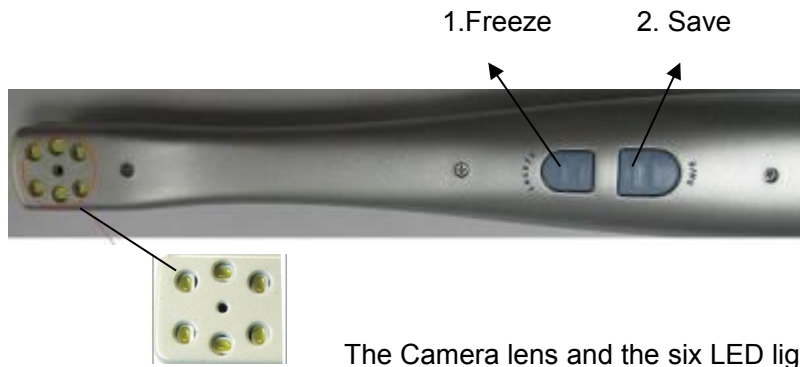

1. Press option 1, Power on the camera; press option 2 for a longer time, power off the camera
2. Press option 1, freeze the image; press option 2, save image into SD card.

C. Side



Wired operation sketch map

- A. Let the cable connect with camera

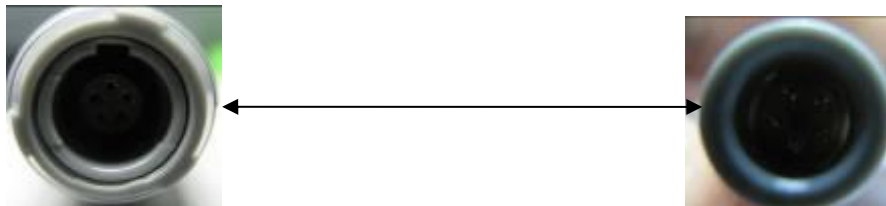

- B. Let the MINI SD card insert into the camera



Notice: Please let the back of SD card insert into the camera.

D, Let another side connect with this machine

E. Use the camera

Press the Freeze button, the camera will be power on, After capture the image, press Save button , the images will be saved into Micro SD card, press the previous and next buttons, customers can check the images which has been captured by camera , Micro SD card can save 500 pictures. Press the switch button, LCD monitor will display the image between X-ray reader and intra oral camera. Press button 1 or 2 on camera, customers can check the captured images anytime. Press button 3, the image will be deleted.

F, Upgrade to wireless system

Connect the intra oral camera with wireless transmitter, and insert the wireless receiver as below picture.



Same as wired camera's operation, press Freeze button, and the camera will be power on, after capture the image, press save button, the images can be saved in the SD card, and press the previous and next buttons, customers can check the images what had been captured by camera.

3.3 Assembly Instruction illustration

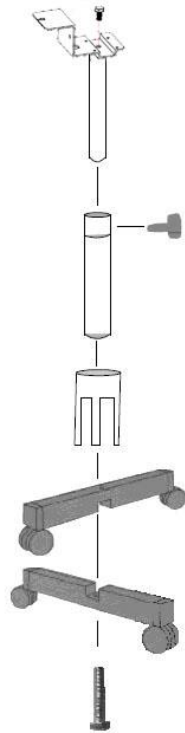

Warning: When this screw is loose, the spring will come out!

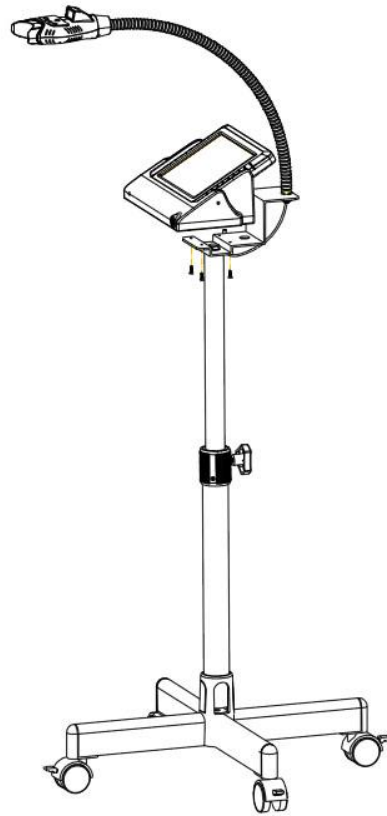

4. How to solve troubles

If there are some troubles of products, Please see below special case firstly. If still can't be solved, please contact your local dealer.

Item	trouble states	resolve methods
1	the products can't be startup when open (ON/OFF)switch)	1.check the power socket if it is ok 2.check the cable if it is connected
2	computer or TV can't reveal images	1.check the connection between products and computer or TV if it is correct 2.check the Driver Setup if it is finished,
3	in the process of use, the image will be a little blurry	If you use it in the first time, it belongs to natural reaction. It will be better later on
4	freezing images then appears dithering	the hand shakes when uses camera to capture image, when users are skillful for use products, the phenomena can be changed
5	the images of computer or TV have spots	1.check the screen if it has spot 2.check the lens if it has spot 3.if the spot can't be cleaned, please contact the local dealer

5. Notice

Prior to installation and start-up of the unit, carefully read the instructions provided herein ,As with all technical devices, the proper function and safe operation of this unit depend on the users compliance with the safety recommendations presented in these operating instructions.

- A) **CAUTION:** It is important to observe the following precautions:
Do not shine the light directly onto or toward unprotected gingival or skin.

- B) **CAUTION:** Persons with a history of photosensitivity or who are using photosensitizing drugs should not be exposed to light from this unit.

- C) **CAUTION:** This is equipment is not suitable for use in presence of flammable anesthetic mixtures with air or nitrous oxide.

- D) **CAUTION:** Please do not look into emitted light by the machine when it is in use or it will hurt your eyes. Please be sure to wear goggles.

- E) **CAUTION:** For the bend angle, please do not exceed 90 degree, or easily broken elbow, it may cause noise in the future.